

NeoGate TA Series Quick Installation Guide

Version: V1.1

Yeastar Technology Co., Ltd.

Date: November 18, 2014

Contents

1. Preparation before Installation	3
2. Hardware Specifications	4
2.1 Overview	4
2.2 LED Indicators and Ports	5
2.3 Specifications and Operating Environment.....	7
3. NeoGate TA Series Installation	8
3.1 Placement Instructions	8
3.2 Installation Instructions.....	8
3.2.1 <i>Wall-mount Instruction</i>	8
3.2.2 <i>Connection of Ethernet Ports</i>	9
3.2.3 <i>Connection of FXS Ports</i>	9
3.2.4 <i>Connection of FXO Ports</i>	10
3.2.5 <i>Power Connection</i>	10
3.2.6 <i>Connection Diagram</i>	10
4. NeoGate TA Series Basic Configurations	12
4.1 Getting an IP Address.....	12
4.2 Logging in the Web Configuration Panel	13
4.3 Network Settings.....	14
4.4 Make and Receive Calls	14
4.5 Reset to Factory Defaults	14
5. Conclusion	15

About NeoGate TA Series Analog VoIP Gateway

NeoGate TA Analog VoIP Gateways are cutting-edge products that connect legacy telephones, fax machines and PBX systems with IP telephony networks and IP-based PBX systems. Featuring rich functionalities and easy configuration, NeoGate TA is ideal for small and medium enterprises that wish to integrate a traditional phone system into IP-based system. NeoGate TA helps them to preserve previous investment on legacy telephone system and reduce communication costs significantly with the true benefits of VoIP.

This Guide explains how to install NeoGate TA FXS Gateways, how to log in web interface, etc.

1. Preparation before Installation

Please make sure the following devices are available before installation:

📦 Contents of the box

Upon receiving NeoGate gift box, please open the package and check if all the items are supplied as NeoGate TA400/410/800/810 Packing List (See Sheet 1) and NeoGate TA1600/2400/3200 Packing List (See Sheet 2). If there is any problem, please contact your provider.

Item	Unit	QTY	Description
NeoGate TA400/410/800/810	PC	1	NeoGate device unit
Power adaptor	PC	1	Power Supply
Network cable	PC	1	
Stand	PC	1	
Warranty card	PC	1	With Serial Number printed for Repair & Return
Quick installation guide	PC	1	

Sheet 1 NeoGate TA400/410/800/810 Packing List

Item	Unit	QTY	Description
NeoGate TA1600/2400/3200	PC	1	NeoGate device unit
Power cord	PC	1	For the input of power
Network cable	PC	1	
Warranty card	PC	1	With Serial Number printed for Repair & Return
Quick installation guide	PC	1	
Mounting ears	PC	2	
Screws	PC	8	8 screws (φ3.0*6 mm) for mounting ears
Grounding stud and nut	Pair	1	
Rubber feet	PC	4	

Sheet 2 NeoGate TA1600/2400/3200 Packing List

2. Hardware Specifications

2.1 Overview



Figure 2-1 NeoGate TA Series Analog VoIP Gateways

Models	Telephony Interfaces		
	RJ11 FXS Ports	RJ11 FXO Ports	RJ21 FXS Ports
NeoGate TA400	4	–	–
NeoGate TA410	–	4	–
NeoGate TA800	8	–	–
NeoGate TA810	–	8	–
NeoGate TA1600	16	–	1
NeoGate TA2400	24	–	1
NeoGate TA3200	32	–	2

Figure 2-2 NeoGate TA Telephony Interfaces

2.2 LED Indicators and Ports

The LED indicators and ports of NeoGate TA400, TA410, TA800, and TA810 are similar; the difference is the number for ports and the type of ports. Take the front panel and rear panel of NeoGate TA800 and NeoGate TA3200 as examples.

Front Panels

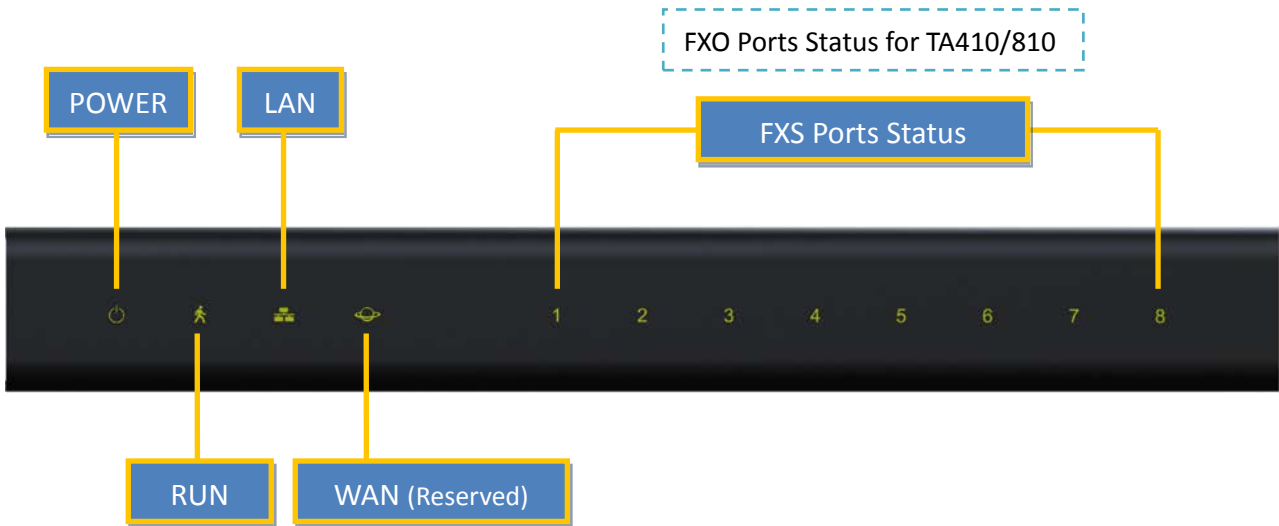

Figure 2-3 NeoGate TA800 Front Panel

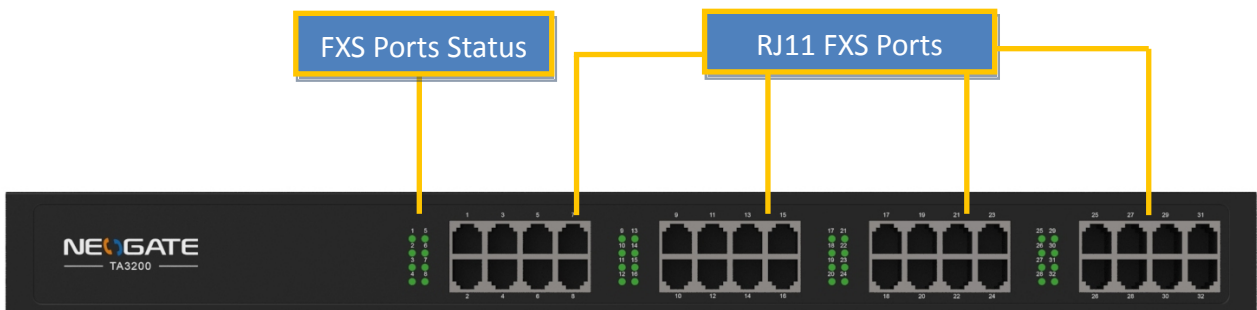

Figure 2-4 NeoGate TA3200 Front Panel

Rear Panels

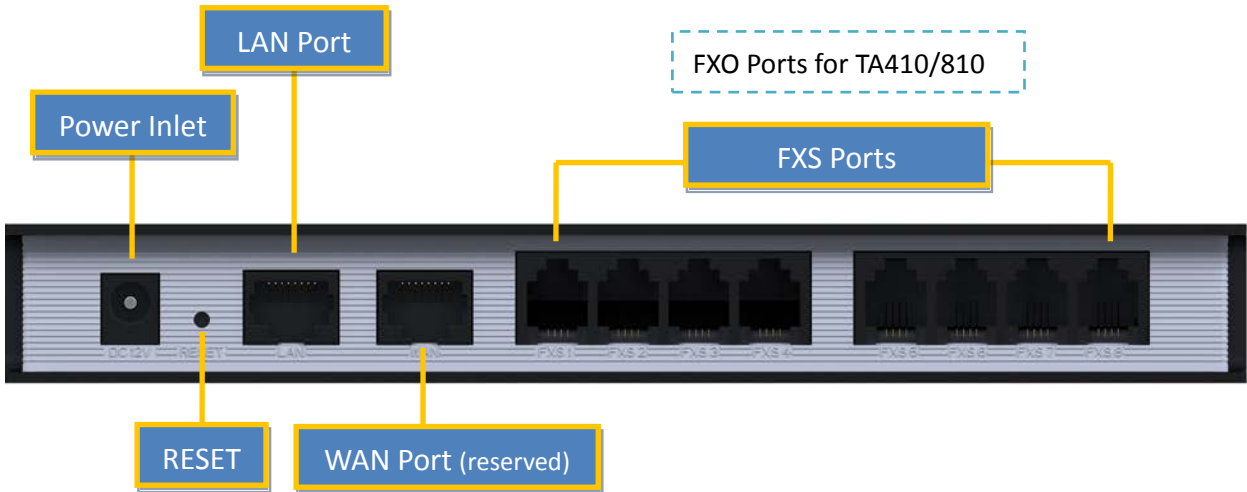

Figure 2-5 NeoGate TA800 Rear Panel

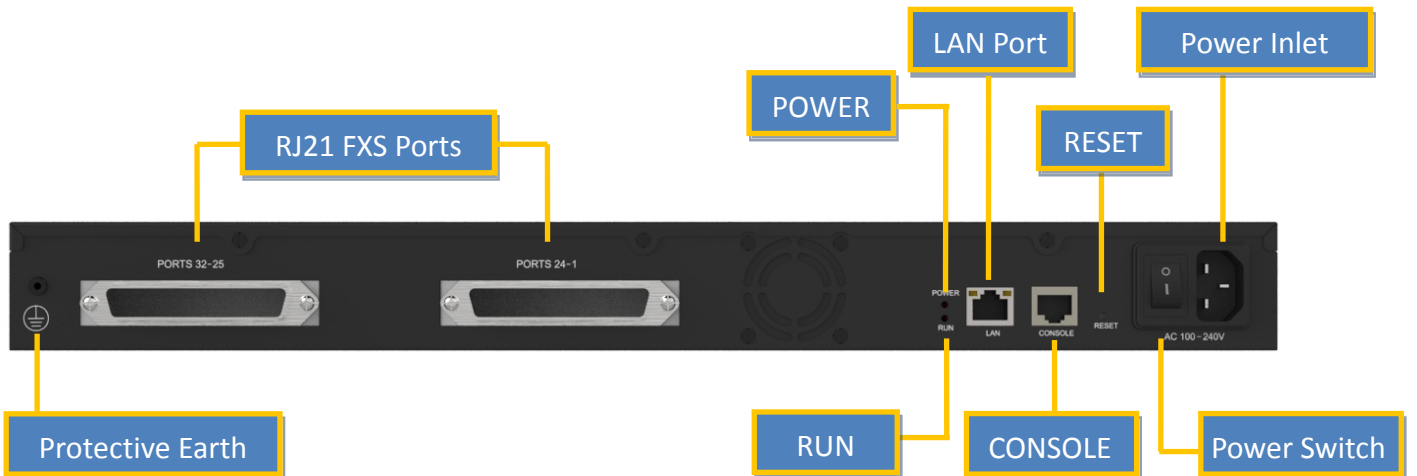

Figure 2-6 NeoGate TA3200 Rear Panel

LED	Indication	Status	Description
POWER	Power status	On	The power is switched on.
		Off	The power is switched off.
RUN	NeoGate status	Blinking	NeoGate is running properly.
		Not Blinking/Off	NeoGate goes wrong.
1-32	FXS Ports Status	Green light	Solid green: the port is idle.
1-8	FXO Ports Status		Green light blinking: there is an ongoing call on the port.

Table 2-1 LED Indications

Ports	Description
Ethernet Port	NeoGate provides 1 10/100 adaptive RJ45 Ethernet ports, marked as LAN. - LAN port : LAN port is for the connection to Local Area Network (LAN).
Reset Button	Press the reset button to restore the factory defaults.  Please make sure that you want to reset, because once reset the previous configurations would be erased automatically.
Power Inlet	For connection of power supply.
RJ11 FXS Ports	For connection of analog phones/fax machines.
RJ11 FXO Ports	For connection of PSTN interfaces or PBX extension interfaces.
RJ21 FXS Ports	For connection of analog phones/fax machines with an RJ21 to RJ11 cable.
RS232 Console Port (TA1600/2400/3200)	For debugging.

Table 2-2 Ports Descriptions

2.3 Specifications and Operating Environment

TA400/410/800/810	Description
Size (L×W×H)	200 mm × 137 mm × 25.6 mm
Power Supply	12V 1A
Operating Temperature	0 to 40°C, 32 to 104°F
Storage Temperature	-20 to 65°C, 4 to 149°F
Humidity	10%~90% (Non-condensing)

Table 2-3 NeoGate TA400/410/800/810 Specifications and Operating Environment

TA1600/2400/3200	Description
Size (L×W×H)	440 mm × 250 mm × 44 mm
Power Supply	AC 100-240V 50/60Hz
Operating Temperature	0 to 40°C, 32 to 104°F
Storage Temperature	-20 to 65°C, 4 to 149°F
Humidity	10% to 90% (non-condensing)

Table 2-4 NeoGate TA1600/2400/3200 Specifications and Operating Environment

3. NeoGate TA Series Installation

 To avoid unexpected accident, personal injury or device damage, please read the following instructions before installing the Gateway.

3.1 Placement Instructions

- ◆ Ambient Temperature: to avoid overheating, please do not run NeoGate TA in the place where the ambient temperature is above 104°F (40°C).
- ◆ Ventilation: please make sure that the device has good ventilation around.
- ◆ Anti-jamming: there may be some sources of interference that might affect the normal running of the Gateway. It's highly recommended that the device
 - Should be placed away from high-power radio, radar transmitters and high frequency, and high-current devices.
 - Is using independent power junction box and effective anti-grid interference measures have been taken.
- ◆ Mechanical load: Please make sure that the device is placed steadily to avoid any accident that might cause damage. If placed on the desktop, please ensure it is horizontally placed.

3.2 Installation Instructions

Place the Gateway in a suitable place, and then connect the power adapter and all other cables to complete the installation.

3.2.1 Wall-mount Instruction

NeoGate TA 400/410/800/810, besides being a desktop device, is also wall-mountable. Mounting the device on the wall could save some space if space is limited.

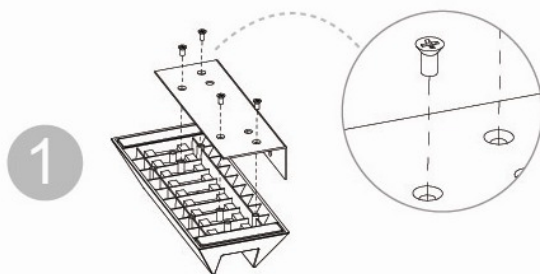

Remove the screws on the stand. The screw the clump weight to the stand again to the stand as the picture shows.

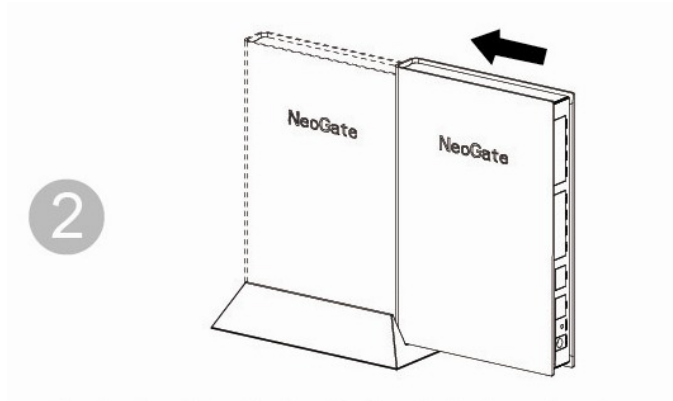

Push the NeoGate device into the stand.

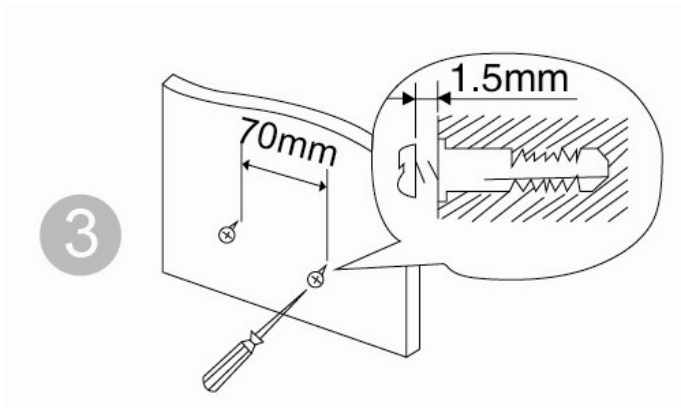

Fix two screws on the wall and then you could mount the stand to the wall.

3.2.2 Connection of Ethernet Ports

NeoGate TA provides one 10/100M adaptive RJ45 Ethernet LAN port.

◆ LAN Port Connection

Connect one end of a network cable to the LAN port of the Gateway, and the other end to any port of company's LAN switch/router.

 If the LAN port is connected to PC directly (not via a switch), please use cross-over cable.

3.2.3 Connection of FXS Ports

NeoGate TA FXS Gateways are available with 5 models, supporting up to 32 FXS ports.

RJ11 Phone Port

Connect one end of a RJ11 phone cable to the port. Connect the other end to your analog telephone.

RJ21 Connection: applicable to NeoGate TA1600/2400/3200.

Connect one end of a RJ21 cable to the connector. Connect the other ends to your analog telephones.

3.2.4 Connection of FXO Ports

NeoGate TA FXO Gateways include TA410 and TA810, supporting 4 and 8 FXO ports respectively.

Connect the FXO interfaces to the Public Telephone Network (PSTN) or a PBX extension interface.

3.2.5 Power Connection

Connect the power adapter to the Gateway's power port, and then plug the power adapter into an electrical outlet. Press the On switch to power on the Gateway. The gateway will start booting. In the meantime, users would see that the "POWER" and "RUN" indicator lights turn on.

 Please switch off the power before plugging or unplugging the cables.

3.2.6 Connection Diagram

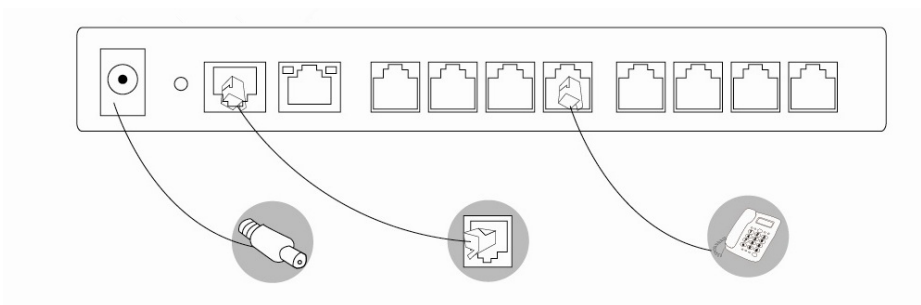

Figure 3-1 NeoGate TA800 Connection Diagram

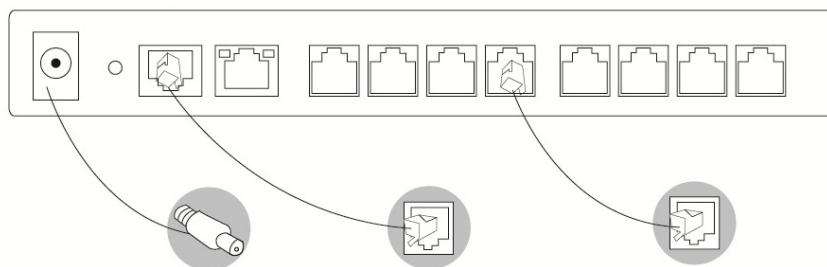

Figure 3-2 NeoGate TA810 Connection Diagram

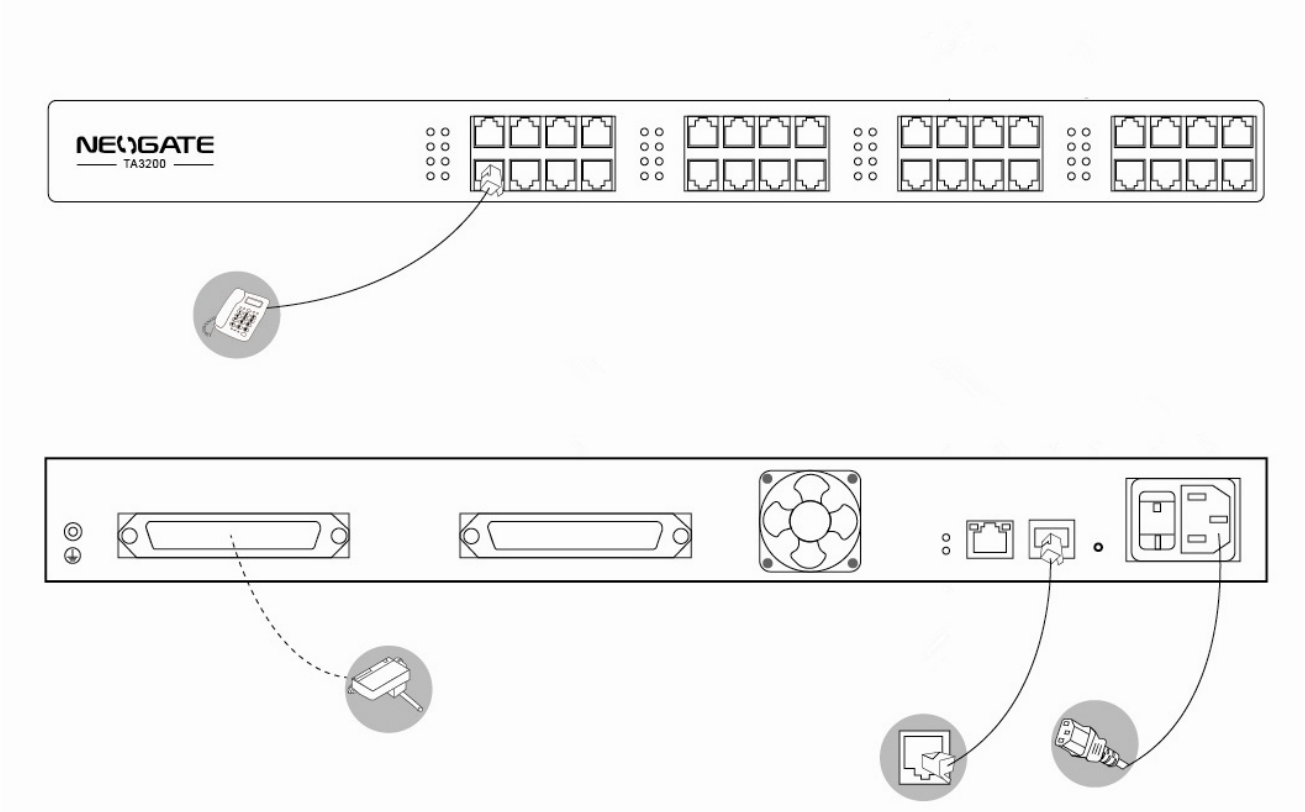

Figure 3-3 NeoGate TA3200 Connection Diagram

4. NeoGate TA Series Basic Configurations

4.1 Getting an IP Address

NeoGate provides web-based configuration interface for administrator and account user. The user can manage the device by logging in the Web interface.

Access path: `http://[IP address]`

User Name: **admin**;

Password: **password**

Default SIP UDP port: 5060

The NeoGate TA attempts to contact a DHCP server in your network to obtain valid network settings (e.g., the IP address, subnet mask, default gateway address and DNS address) by default.

Please enable DHCP Server in your network to obtain the IP address.

Due to the difference of telephony interface, NeoGate TA FXS Gateway and FXO Gateway will use different methods to check the IP address.

NeoGate TA FXS Gateway

1. Use an analog phone connected to the FXS port of the Gateway, press ******* to get into the IVR menu. Enter **1** to obtain the Gateway's IP address.
2. If there is no DHCP server in the network, press **3** for advanced setting, and press **2** to assign a static IP address to the device.

NeoGate TA FXO Gateway

1. Download a DeviceFound tool from Yeastar website: [FindTA.rar](#)
2. Run the DeviceFound.exe software.
3. Find the IP address by the device's MAC address or the SN.

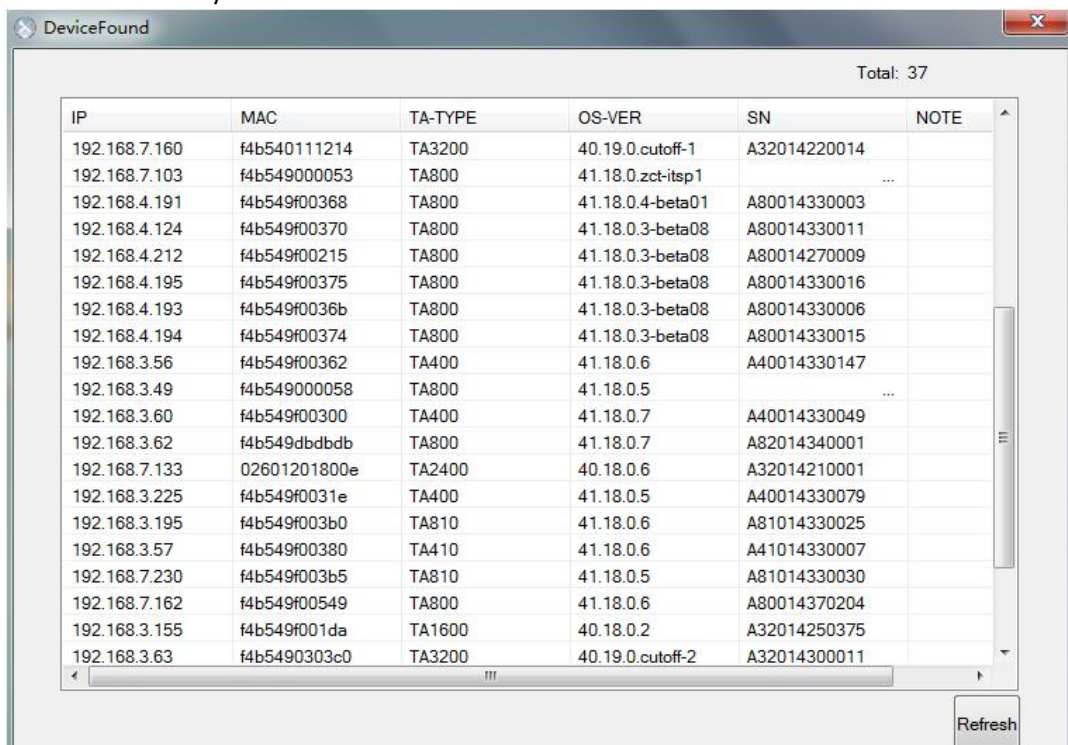

The screenshot shows the DeviceFound application window with a table of discovered devices. The table has columns for IP, MAC, TA-TYPE, OS-VER, SN, and NOTE. The total number of devices found is 37.

IP	MAC	TA-TYPE	OS-VER	SN	NOTE
192.168.7.160	f4b540111214	TA3200	40.19.0.cutoff-1	A32014220014	
192.168.7.103	f4b549000053	TA800	41.18.0.zct-itsp1		...
192.168.4.191	f4b549f00368	TA800	41.18.0.4-beta01	A80014330003	
192.168.4.124	f4b549f00370	TA800	41.18.0.3-beta08	A80014330011	
192.168.4.212	f4b549f00215	TA800	41.18.0.3-beta08	A80014270009	
192.168.4.195	f4b549f00375	TA800	41.18.0.3-beta08	A80014330016	
192.168.4.193	f4b549f0036b	TA800	41.18.0.3-beta08	A80014330006	
192.168.4.194	f4b549f00374	TA800	41.18.0.3-beta08	A80014330015	
192.168.3.56	f4b549f00362	TA400	41.18.0.6	A40014330147	
192.168.3.49	f4b549000058	TA800	41.18.0.5		...
192.168.3.60	f4b549f00300	TA400	41.18.0.7	A40014330049	
192.168.3.62	f4b549dbdbdb	TA800	41.18.0.7	A82014340001	
192.168.7.133	02601201800e	TA2400	40.18.0.6	A32014210001	
192.168.3.225	f4b549f0031e	TA400	41.18.0.5	A40014330079	
192.168.3.195	f4b549f003b0	TA810	41.18.0.6	A81014330025	
192.168.3.57	f4b549f00380	TA410	41.18.0.6	A41014330007	
192.168.7.230	f4b549f003b5	TA810	41.18.0.5	A81014330030	
192.168.7.162	f4b549f00549	TA800	41.18.0.6	A80014370204	
192.168.3.155	f4b549f001da	TA1600	40.18.0.2	A32014250375	
192.168.3.63	f4b5490303c0	TA3200	40.19.0.cutoff-2	A32014300011	

Figure 4-1 Find the IP address of NeoGate TA with DeviceFound.exe

4.2 Logging in the Web Configuration Panel

Start the browser on PC. In the address bar, enter the IP address, click “Enter” button and then you can see NeoGate Web Configuration Panel login page.

VoIP Analog Gateway for Cost Reduction

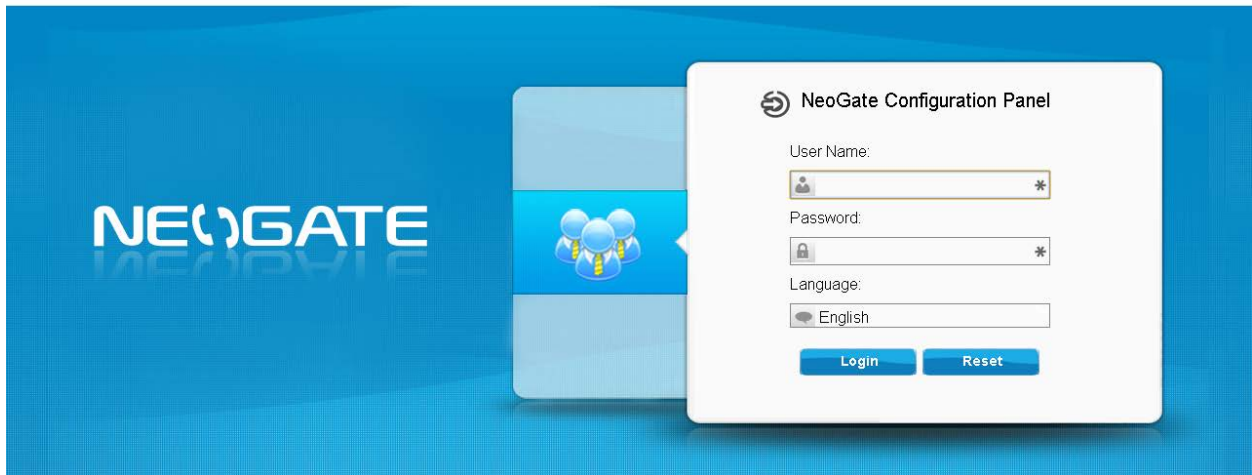

Copyright © 2006-2014 Yeastar Technology Co., Ltd. All Rights Reserved.

Figure 4-2 NeoGate TA Web Configuration Panel Login Page

Enter the Admin User Name and Password to log in.



Figure 4-3 NeoGate Admin Configuration Interface

Via the configuration interface, the admin can make all the system configurations, including network settings (LAN, WAN, Firewall, VPN, DDNS, VLAN, etc.); system parameters configuration (time zone, password, etc.); internal settings (Web access port, etc.); FXS ports list; FXO ports list; Hunting Groups; Hotline; call logs (search, download); firmware update and reset, etc.

 After saving the changes, remember to click the “Apply changes” button to make the changes take effect.

4.3 Network Settings

After logging in the admin configuration interface, generally the first step is to configure the IP address. If the LAN ports are connected to the network, their IP addresses need to be configured. If not, just configuring the IP address of the LAN port which is connected to the local area network of the company is OK.

◆ LAN Settings

Click “Network Preferences”-> “LAN Settings” on the left menu bar of the web configuration interface.

LAN port is used for the interoperability of IP terminals and NeoGate. If the LAN port is connected to the company’s LAN, please configure the correct IP address and corresponding subnet mask.

 Please note that after changing the IP address of LAN port, NeoGate should be rebooted to make the new changes to take effect.

4.4 Make and Receive Calls

NeoGate TA FXS Gateway

1. Internal calls between FXS ports

Two analog phones connected to NeoGate TA could make calls between them by dialing *99+FXS port number.

2. Outbound and inbound calls

Users should be able to make and receive external calls after configuring FXS Ports, VoIP Server, and Dial Pattern. Please refer to *NeoGate TA FXS Gateway User Manual* for details.

NeoGate TA FXO Gateway

1. Route calls from a PSTN number to IP-PBX

Users should be able to receive PSTN-to-VoIP call after configuring FXO Ports, VoIP Server, Dial Pattern and Port -> IP. Please refer to User Manual for details.

2. Route calls from VoIP trunk to a PSTN number

Users should be able to make VoIP-to-PSTN call after configuring FXO Ports, VoIP Server, Dial Pattern and IP -> Port. Please refer to *NeoGate TA FXO Gateway User Manual* for details.

4.5 Reset to Factory Defaults

To reset to factory defaults, you could follow the below instruction:

Press the “RESET” button located in the back panel with a paper clip or a pencil tip. You can see the RUN indicator stops flicker and turns solid. When the RUN indicator turns off, the button could be released and system begins to reset. During the process, please do not power off until the RUN indicator become normal which means the reset process is completed.

 Note: After resetting, all the configurations made by the admin would be erased.

5. Conclusion

This Installation Guide only explains the installation and basic settings of NeoGate TA Series Analog VoIP Gateways. For more functionality and advanced settings, please refer to the relative documents as below:

“NeoGate TA Series Analog VoIP Gateways Datasheet”

“NeoGate TA FXS Gateway User Manual”

“NeoGate TA FXO Gateway User Manual”

[The End]